



**2024 Sail East and  
ILCA Canadian Championships at the Bay Wind Regatta  
July 19, 20 and 21, 2024  
GREEN FLEET SAILING INSTRUCTIONS**

*These sailing instructions generally conform to the Canadian Optimist Dinghy Association and Sail Nova Scotia standards for Green Fleet racing. They are more suitable for use by race committees and coaches in support of the Green Fleet than as direct reading by younger Green Fleet competitors.*

**1. RULES**

- 1.1. The regatta will be governed by the rules as defined in The Racing Rules of Sailing (RRS).
- 1.2. Rule 40.1 applies at all times while afloat in accordance with the last sentence of Rule 40.2.
- 1.3. Sailing instructions may be amended orally afloat for the Green Fleet in accordance with Rule 90.2(c) by displaying Code Flag L and informing coaches and competitors of the change. Such changes will also be posted later.
- 1.4. Since Green Fleet races are not scored:
  - 1.4.1. Redress is not available to competitors under Rule 62.1(a) for an improper action or omission of the Organizing Authority or the Race Committee; and,
  - 1.4.2. Rule 64.2 is changed so that the protest committee is not required to impose a penalty when they find that a party to a protest hearing has broken a rule and is not exonerated.

**2. NOTICES TO COMPETITORS**

- 2.1. The official notice board and all official documents and communications shall be located on the event website: <https://baywind.smsc.ca>.
- 2.2. The Race Committee may give oral instructions, including amendments to sailing instructions, to Green Fleet competitors, by communicating directly with individual competitors or communicating indirectly through designated Green Fleet coaches.
- 2.3. The Race Committee will signal that oral instructions are available by displaying Code Flag 'L' with one sound signal.
- 2.4. The Race Committee may display a summary of oral instructions afloat by means of a whiteboard.



2.5. A record of oral instructions that change sailing instructions will be posted on the official notice board at the end of a day's sailing if further sailing is scheduled the next day.

**3. SIGNALS MADE ASHORE**

- 3.1. Signals made ashore will be displayed from the flagpole located on the water side of the SMSC Main Clubhouse.
- 3.2. If a postponement is signaled ashore, the warning signal will be made not less than 30 minutes after flag AP is lowered.

**4. SCHEDULE and CLASS FLAGS**

Saturday, July 20, 2024		Sunday, July 21, 2024	
09:30	Skippers and coaches meeting	09:30	Skippers and coaches meeting
11:00	First warning signal Subsequent races to follow	11:00	First warning signal Subsequent races to follow
		14:30	Last warning signal

4.1. The Optimist class flag is a red optimist symbol on a green flag



4.2. The C420 class flag is a red 420 symbol on a green flag



**5. RACING AREA**

The racing area will be inside French Village Harbour, west of the breakwater, in the Charlie circle shown below.

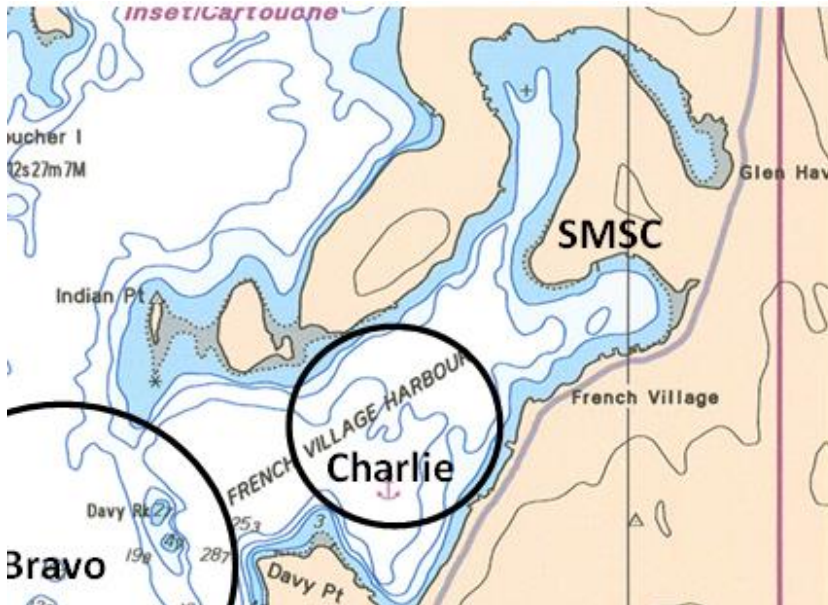

## 6. COURSE and MARKS

6.1. Green Fleet will sail a simplified course, as shown below. Marks will be left to port.

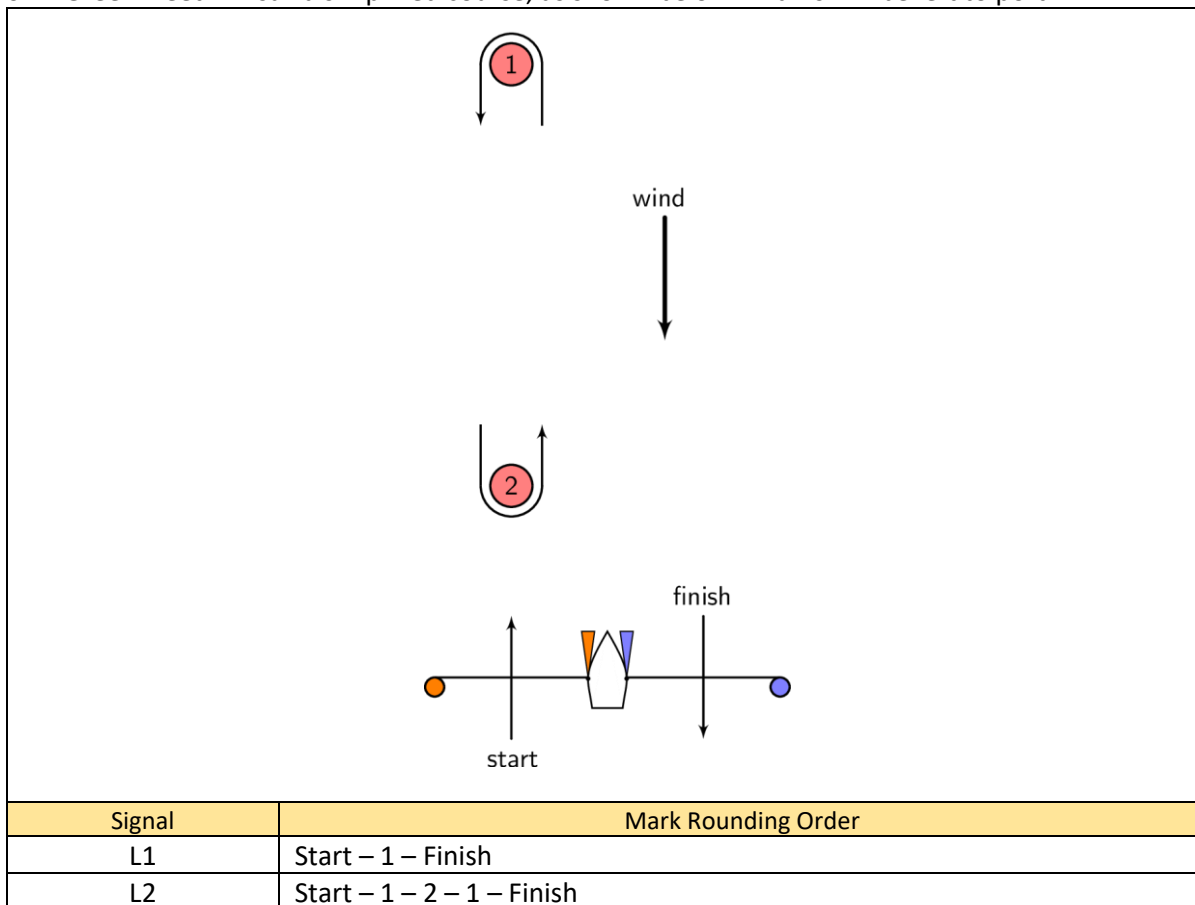

6.2. Marks 1 and 2 will be orange inflatable tetrahedrons.

6.3. The start mark will be a yellow inflatable pin.



6.4. The finish mark will be a pink mooring ball.

## 7. STARTING and FINISHING LINES; STARTING SYSTEM

7.1. The starting line will be between the staff on the race committee boat flying and orange flag and the course side of the nearby start mark.

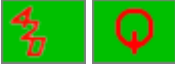

7.2. The finishing line will be between the staff on the race committee boat flying a blue flag and the course side of the nearby finish mark.

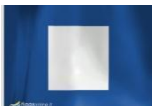
7.3. Races will be started using Rule 26 with the warning signal made 5 minutes before the starting signal, that is:

Time to Start	Description	Flag
5 Minutes	Class flag raised with one sound signal	
4 Minutes	Preparatory flag raised with one sound signal	
1 Minute	Preparatory flag lowered with one sound signal	

Start	Class Flag lowered with one sound signal	
-------	--	---

7.4. If one or more boats are on the course side of the starting line at the starting signal the Race Committee may signal an individual or a general recall signal, that is:

Individual Recall	One sound signal with Flag X	
General Recall	Two sound signals with Flag 'first substitute'	

## 8. PROTESTS

- 8.1. Protests shall be delivered to the Race Committee before the post-racing debrief. Open hearings will be held during the post-race debrief to familiarize the competitors with protest procedures. The results of the hearing will be given orally. Written decisions will not be prepared unless requested.
- 8.2. As an alternative to a formal protest hearing, at the request of a competitor or coach a member of the protest committee may hold an informal debrief with the competitors and their coaches.

## 9. SCORING AND PRIZES

- 9.1. The Race Committee will offer as many races as practical within a target time of approximately 3 ½ hours on the water per day.
- 9.2. Races will not be scored but the raw finishing order will be posted for each race.

## 10. ON-WATER COACHING AND SUPPORT BOATS

- 10.1. Coaches may coach competitors during racing but should not coach a competitor when in close proximity to another unless coaching support is supplied to both.
- 10.2. Spectator and support boats not coaching should not enter the course during racing.
- 10.3. Support boats shall monitor the Race Committee working channel. Coaches are essential to the safety plan of the regatta, and they are required to assist in providing safety cover to competitors on the water.
- 10.4. The Race Committee working channels will be:

Course	Channel
Alpha	71
Bravo	72
Charlie (Green)	69
SMSC	68

## 11. Safety Regulations

- 11.1. When leaving the harbour and again when returning, competitors shall sail through a gate formed by a buoy and the end of the breakwater so that the race committee (seagulls) can record the numbers of boats departing and returning to harbour. If boats are being towed, they must be towed through the gate, and must hail their sail numbers if their sails are not hoisted.